

Many traditional quilt patterns contain squares made from two contrasting half-square triangles. These are called bias-square units. Using the Bias Square ruler and the following bias-strip-piecing method, you can easily sew and cut bias squares in many sizes.

1. Cut two fat quarters of contrasting fabric and layer them right sides up.
2. Align the diagonal (45°) mark of the Bias Square along the left edge of the layered fabric. Place a 24" ruler against the right edge of the Bias Square and adjust the rulers so the right edge of the long ruler intersects the corner of the fabric. Make the first cut from the corner at a 45° angle.

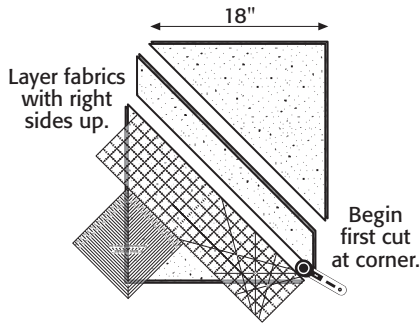

3. Referring to the chart, determine how wide to cut the bias strips. Cut the fabric into strips.
4. Arrange the strips in the order you will sew them. Beginning with the corner, select a strip from the top layer; then select the strip next to it from the bottom layer. Continue in this manner, alternating strips from the top and bottom layers. You will have two sets of strips to sew together.

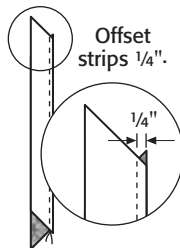
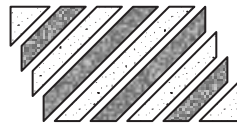

5. Join the strips along the long bias edge, right sides together, using 1/4"-wide seam allowances. Offset the strips 1/4" as shown. The lower edge of the pieced rectangle and the adjacent side edge must form straight lines after sewing.

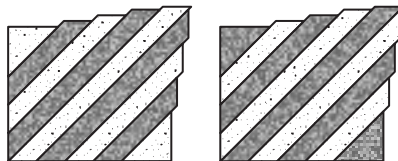

6. Press the seams toward the darker fabric.

7. Begin cutting at the lower left corner of each unit. Align the 45° mark of the Bias Square ruler on the seam line so you are cutting a square that is slightly larger than necessary. Cut along the side and top edge of the ruler.

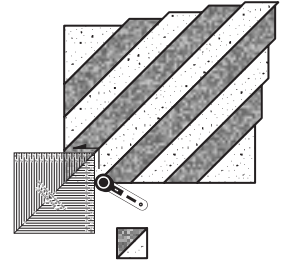

8. To make the second cut, rotate the segment. Align the Bias Square with the two previously cut sides and the 45° mark on the seam line. Trim the two remaining sides.

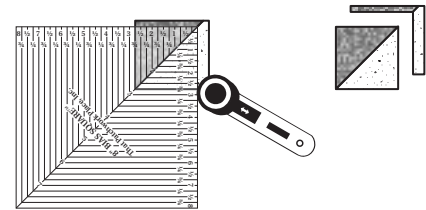

Turn cut segments and cut opposite two sides.

9. Continue cutting bias squares from each strip unit, working from left to right, from bottom to top, and row by row, until you have cut bias squares from all usable fabric.

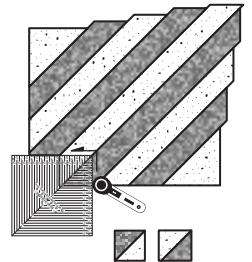

Finished Size of Bias Square	Strip Width	Cut Size of Bias Square
1"	1 3/4"	1 1/2"
1 1/4"	2"	1 3/4"
1 1/2"	2"	2"
1 3/4"	2 1/4"	2 1/4"
2"	2 1/2"	2 1/2"
2 1/2"	2 3/4"	3"
3"	3"	3 1/2"
4"	3 3/4"	4 1/2"